

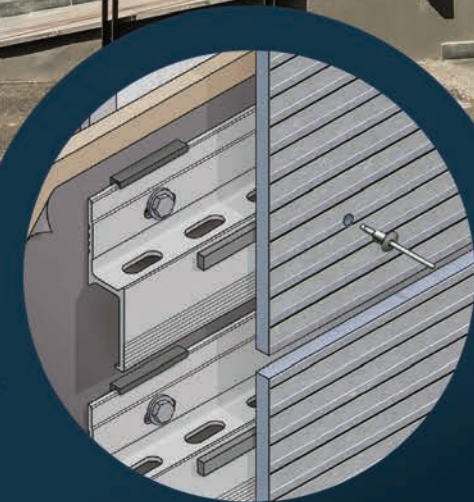

Patina Inline XKELEX Z19 Installation Guidelines

ARCHITECTURAL PANELS



Patina Inline -XKELEX Z19
Aluminum Profiles with Rivets

+ RAINSCREEN APPLICATION
9.5 MM PANELS



These guidelines represent an abbreviated illustration for proper installation of Patina Inline with horizontally oriented XKELEX Z19 profiles. Additional guidelines for interior applications, hidden adhesive attachment, sealing, and weather barrier attachment can be found at americanfibercement.com.

Note: The online copy of the Installation Guidelines obtained at americanfibercement.com supersedes any printed copy.

Construction Practices

1. Air space at top and bottom of building or wall termination to be 25 mm (1") to facilitate airflow from out behind the panels. Do not block vertical airflow at windows, doors, eaves, or at the base of the building. Airflow needs to be continuous from bottom to top so there is air movement behind each panel. See item 4 under Building/Structure on page 4 for proper profile depth based on wall height. 1" is required for walls between 15ft and 60ft. Vertical airflow behind the fiber cement panels is a critical necessity in rainscreen constructions.
2. For areas that receive moderate to high snowfall, panels must terminate 6 to 12 inches above grade line based on expected snow build-up.
3. A metal drip edge may be used at window heads, door heads, and the panel base, but it must not restrict airflow ($\frac{3}{4}$ "; 1" at base openings).
4. Install panels from top of building to bottom.
5. For straight walls, start panel installation in center and work outward.
6. For walls with inside corners, start installation there and work across wall.
7. Jobsite storage:
 - Keep material laying flat, under cover, dry and protected with a waterproof tarp.
 - Transport material on edge.
 - Using a microfiber cloth, brush off any material dust generated by drilling or cutting prior to installation.
 - Do not use the shipping crates or pallets containing the fiber cement panels as a work surface. Keep panels dust-free.
8. For field cuts and drilling, use carbide or diamond blades/bits and slower turning/feed rates. AFC offers saw blades and drill bits.
9. See AFC's Fabrication, Maintenance, and Storage guidelines.

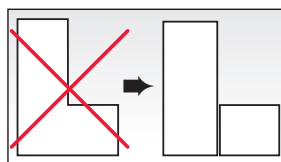

L or C-Shaped panels are not allowed.

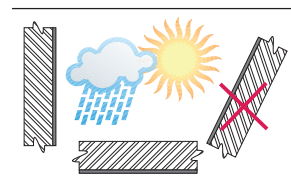

Panels exposed to weather (rain, sun) may only be assembled vertically. Soffit applications not exposed to weather are allowed.

Rainscreen Cladding

Preventing Thermal Bridges

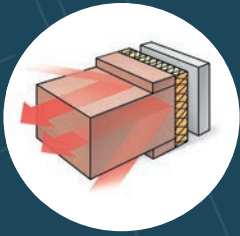

As the insulating material is on the outside of the structural wall, it can easily be mounted without interruptions caused by floor slabs. In this way, any thermal bridges that occur at each floor slab can be prevented. These thermal bridges are also the cause of surface condensation that may result in fungus growth.

Dissipating Heat From the Sun

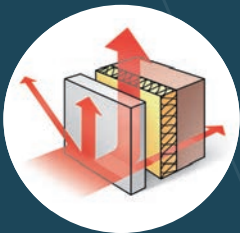

The ventilated rainscreen cladding system has a cooling effect when temperatures outside are high. Most of the sun's rays are reflected away from the building. Heat passing through the exterior wall panel is partially dissipated by the ventilating effect of the air space between the exterior cladding panel and the structural wall. Any residual heat managing to penetrate buildings is very minor.

Rainscreen

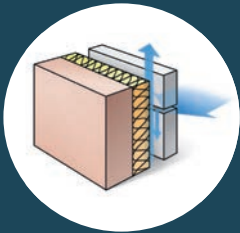

Architectural wall cladding panels act as a rainscreen on the outside of the building and keep the structural wall absolutely dry. The air space connected to the outside air evacuates water and humidity that might have penetrated behind the wall cladding panels through its horizontal or vertical joints. This water will never reach the load-bearing wall and/or the thermal insulation.

Protecting the Basic Structure and Load Bearing Wall Against Temperature Variations

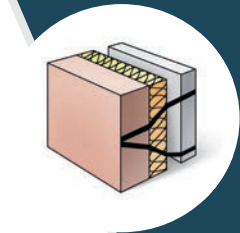

In view of the fact that the insulation material is applied to the outside of the building, changes in temperature are very minor compared with those found in conventional constructions where insulation is applied on the interior. This principle works in summer and winter, in both hot and cold climates.

Prevention of Internal Condensation

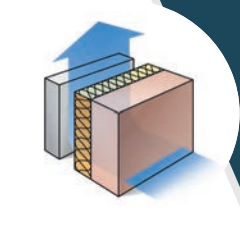

Insulation material can be applied to the outside of the structural wall because it is protected effectively by the architectural exterior wall panel. Because of differences in vapor pressure and temperature passing through the wall, condensation has been shown to occur close to the ventilated area and not in the structural wall itself. As a result, the ventilating effect is easily sufficient to dry out the thermal insulating material.

Panels exposed to weather (rain, sun) may only be assembled vertically. Soffit applications not exposed to weather are allowed.

1. **Architect / Engineer / Contractor to design and build structurally sound, water-tight exterior wall.**

- Substructure Horizontal Straightness Tolerance: ± 3.0 mm per 2 m (± 0.0625 " per 42")
- Substructure Vertical Straightness Tolerance: ± 0.5 mm per 600 mm (± 0.0625 " per 75")

If the wall is not straight, the profiles should be shimmed to create a flat plane for the panels. Shims should not be used between the profile and the panel.

2. **Attach profiles to exterior walls. Structural engineer to determine fastening/affixing specification, i.e. quantity and type of attachment and fasteners, based upon exterior wall construction. Attachment must support 3.2 lbs/ft² (8 mm panel) dead load, plus design wind loads. Fasteners in profile must accommodate thermal expansion/contraction of metal and not interfere with panel application. Shortening the length of the profiles can minimize thermal expansion and contraction. It is also recommended to oversize holes at or near the tops and bottoms of the profiles while having fixed points near the center. This reduces stress in the panels.**

FIG. A

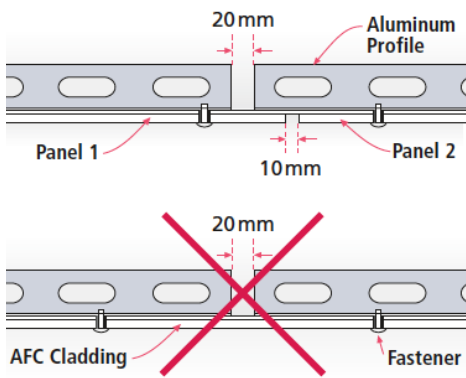

FIG. B

Interior profile. Affix adhesive foam tape to either or both sides of rivet. (Foam tape will compress to correct depth when panel is fastened.)

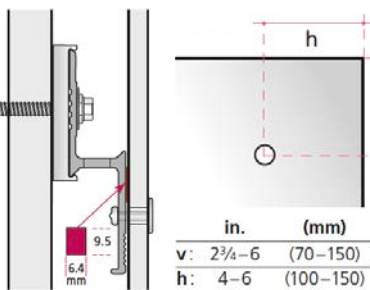
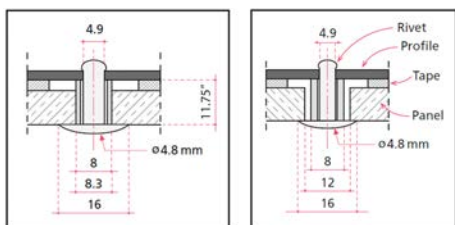

FIG. C

FIG. E



Fixed Point — cylinder & rivet Gliding Point — cylinder & rivet

3. XKELEX Z-19 Profiles are 6063-T5 aluminum with custom cross-sectional shapes with thicknesses varying from 2–3 mm. Profile depth is $\frac{3}{4}$."

4. The Z19 profile is a $\frac{3}{4}$ " depth horizontally oriented profile with perforations. To allow for enough ventilation, the $\frac{1}{4}$ " thermal spacer must be used. For buildings with panel runs greater than 60ft in length vertically, contact your AFC representative. For buildings over 150 feet high, special provisions are required; check with your AFC representative.

5. Two Z19 profiles are used at horizontal joints. The maximum profile length is 10 feet. Panel can be cantilevered $\frac{1}{2}$ " – 3" over edge profile so vertical joint is open. See Figure C for hole placement requirements. (See FIG. C)

6. Profiles to be straight, plumb, level and aligned correctly on the building. **The typical application for this system is a wall assembly without exterior insulation. The Z19 panels are fastened through the sheathing and into the studs using A2 SS #12 x 2" screws w/ washers (supplied by AFC). The profiles are spaced max. 24" on center up the wall.** (See FIG. J)

7. **It is recommended to take field measurements before panels are cut or drilled.** Field measurements verify print dimensions to ensure proper fit.

8. Spacing between horizontal profiles to be ≥ 20 mm ($\frac{3}{4}$ "). A joint between the horizontal profiles must always coincide with a joint between the panels (FIG. A). The joint is preferably continued at the same horizontal height among adjacent profiles. (Reduces stress in panels).

Note: The XKELEX profiles should only cantilever over the vertical profiles by 6" or less. If farther, a structural engineer must be consulted.

9. For structures with exterior insulation, follow the insulation manufacturer's installation instructions. Vertical metal profiles (the same depth as the exterior insulation) can be attached to the exterior wall. The H19 or Z19 metal profiles are then attached to the vertical profiles.

Prepare Profile

1. Typical vertical and horizontal joints are left open and have a black background (use a black weather and UV resistant building wrap). Metal profiles visible at joint openings (vertical or horizontal) can be covered with a black UV weather resistant tape or UV weather resistant coating. Other reveal colors are possible if desired.

2. Affix adhesive foam tape (supplied by AFC) to the profile's full length — 1 strip on the top side of the rivet location or 1 strip on each side of the rivet location. (See FIG. B)

3. Horizontal and vertical joints can be closed with aluminum profiles (21 gauge or less) if desired.

Profile Attachment – ILLUSTRATED

For wall assemblies utilizing exterior sheathing with low screw-holding strength, a two-layer attachment system may be required. (See fig. D-1B)

Contact your AFC representative or visit AFC's website for application instructions utilizing Dynamic Bond adhesive

FIG. D-1A-

Two Z-profiles may be used at a horizontal joint (recommended)

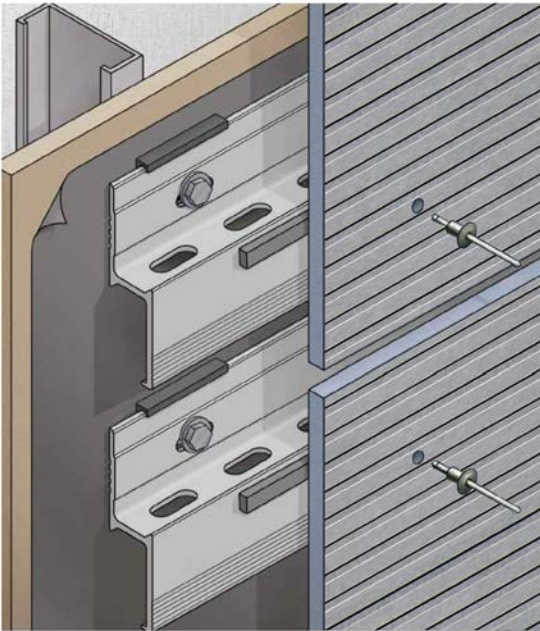
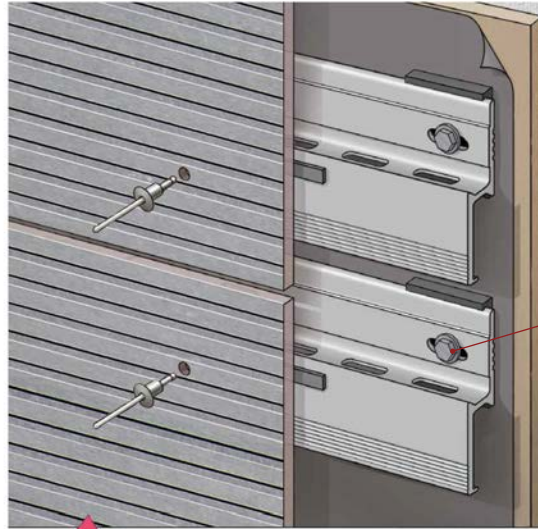

FIG. D-1B-

Building wrap per AFC. Weather and UV resistant. Check local codes for proper placement.



Horizontal member fastened into studs

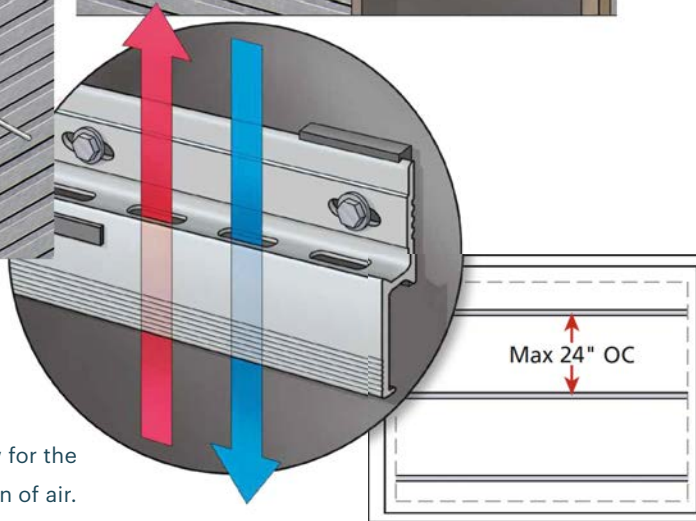

FIG. D-2-

Slots in the profile plus the spacer gap allow for the drainage of water and circulation of air.

FIG. J

Cross-section showing ventilation and attachment to steel studs.

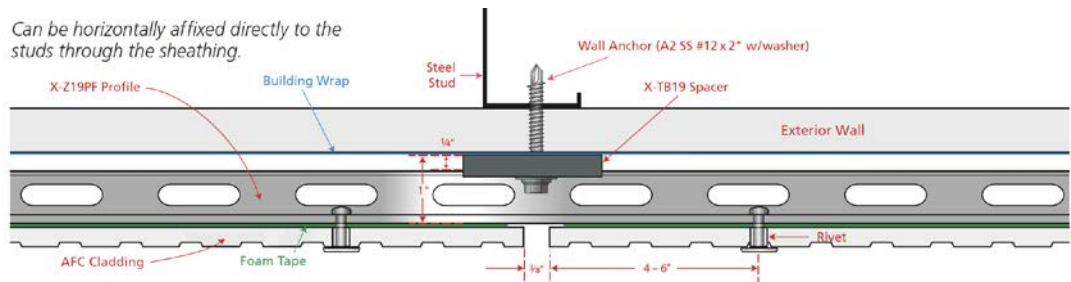

FIG. H Astro Rivet® with fixed cylinder

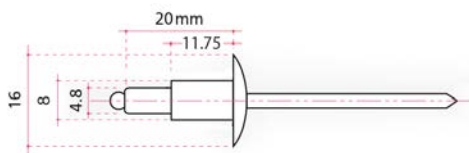

FIG. I Centralizing drill bit



For centering pilot hole in profile for Fixed Points and Gliding Points.

Panels

1. Patina Inline has a sanding grain that must be accounted for when positioning panels. Rotating some panels 90° from the orientation of adjacent panels can result in the appearance of colorshading.
2. Vertical and horizontal joints to be 10mm (3/8"). This is the minimum distance between the edges of two adjacent panels, or the distance from panel edge to metal trim extrusions or structural members. (See FIG. A)
3. Pre-drill holes in panel so that there are: (See FIGS. E, F, G)
 - Two (2) fixed points per panel (F).
 - The rest of the holes are to be gliding points (G).
 - See Fixing section (and FIG. F & G) for determining location of fixed points in each panel.

All holes must be centered on the non-grooved portion of the panel. (See FIG. J-1)

VENTILATED RAINSCREEN APPLICATION

4. Diameter of the fixed point (F) hole is to be 8.3 mm.
5. Diameter of the gliding point (G) hole is to be 12mm. 8.3 mm and 12 mm drill bits supplied by AFC.
6. Joints between profiles must coincide with horizontal joints in the panels. Panels cannot bridge a break in the profiles. (See FIG. A)
7. The pilot hole in metal profile must be in the center of both the fixed point and gliding point holes. Use drill bit centralizing fixture (supplied by AFC) to accomplish this geometry. Pilot hole to be 4.9 mm in diameter — use #10 drill bit (4.9 mm). (See FIG. I)
8. After first affixing the two fixed-point rivets, affix the rivets in a manner moving from nearest the center of the panel to the outside ring. (See FIG. K)

Fixing

1. Rivets to be Astro Rivet (supplied by AFC) with colored or stainless steel head with 8 mm x 11.1 mm cylinder. Shank of rivet is 4.8 mm x 20 mm long, with a 16 mm diameter head. (See FIG. H)
2. Fixing pattern is typically either 16" or 24" (max) on center horizontally (based upon vertical profile spacing) and 16" to 24" (max) on center vertically, depending upon building height, building location, design criteria/specifications, and panel/fastener location on building. Edge areas on facades and high wind load conditions require closer fixing distances. Structural engineer to determine spacings. For soffit applications, the maximum fastener spacing is 16" on center in both directions.
3. Corner rivets to be located at 70-150mm (2 3/4" - 6") horizontally and 100 - 150 mm (4" - 6") vertically from every corner of panel. (See FIG. C)
4. 10mm (3/8") clearance is required from the edge of metal profile to pilot hole for rivet.
5. Two fixed points are required per panel. (See FIG. I & J) Fixed points (for attachment to vertical profiles) are:
 - Always the same height in each panel.
 - As close to center of panel as possible, and then either the next adjacent point to the left or right. Be consistent in panel-to-panel location (center and left or center and right, so fixed points are at the same level horizontally for attachment to vertical profiles).
 - No two fixed points on one panel can be on the same profile, and no two fixed points on two adjacent panels can be on the same profile when adjacent panels share a profile at a vertical joint.
 - For smaller panel sizes with only two rows of fasteners, fixed points to be top center and top left or top right (horizontal applications on vertical profiles). For vertical narrow panel applications on vertical profiles, vertical joints must incorporate two separate profiles (as illustrated. (See FIG. K)

FIG. F -
Vertical installation on horizontal profiles

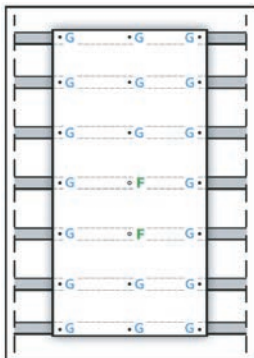

The center column must be centered on the panel.



FIG. G -
Horizontal installation on horizontal profiles. When there is an even number of fastener columns as shown, the Fixed points should be diagonal from one another to provide equal

FIG. K -
Fixing sequence
Attach fixed points first.

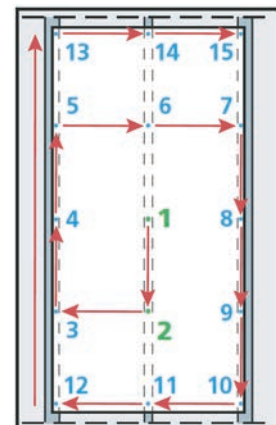

Fixing (Continued)

6. Joint closures can be installed (maximum thickness of finishing profile to be .8 mm or 21 gauge). Standard practice is to leave the joints open. If the joints are closed, the base and parapet openings must be increased to a minimum of 1½".
7. Pilot hole for rivet in metal profile to be 4.9 mm diameter. See Panel section for drill size. (See **FIGS. E AND I**)
8. Remove drill shavings from metal profile holes and panel fixed and gliding holes prior to installing rivets.

Fabrication/Maintenance/Storage

Panels can be used full size (4' x 8' or 4' x 10'), or fabricated to smaller dimensions.

Typical Pattern Layout

Panels can be used full size (4' x 8' or 4' x 10'),

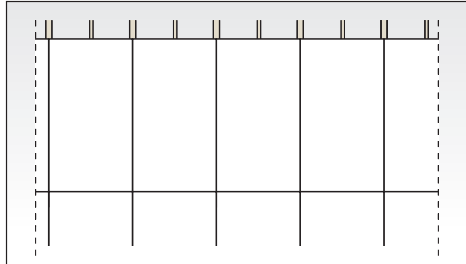

Straight
pattern with
vertical panels

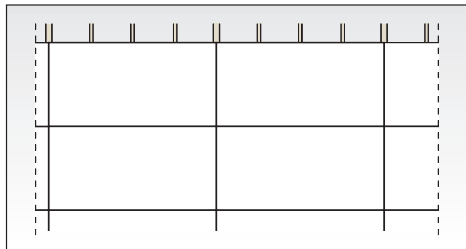

Straight
pattern with
horizontal
panels

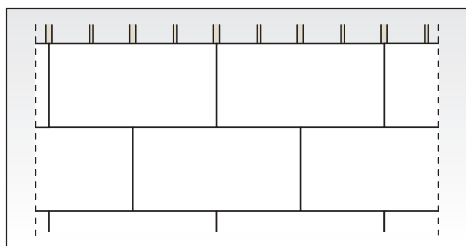

Semi
pattern with
horizontal
panels



Typical Horizontal Panel Joint

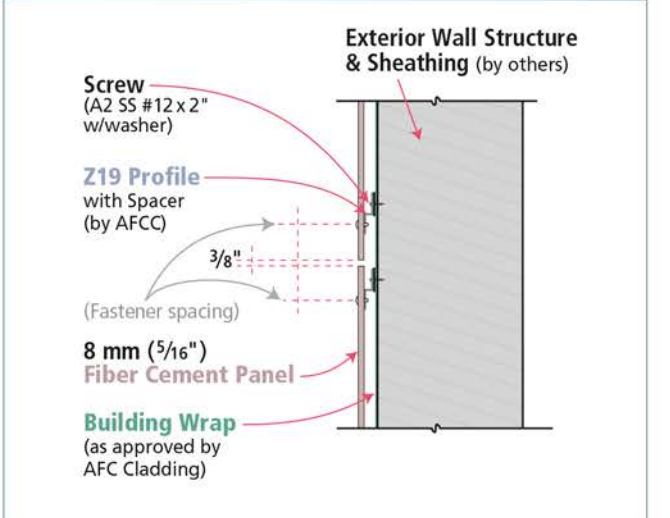

Typical Vertical Panel Joint

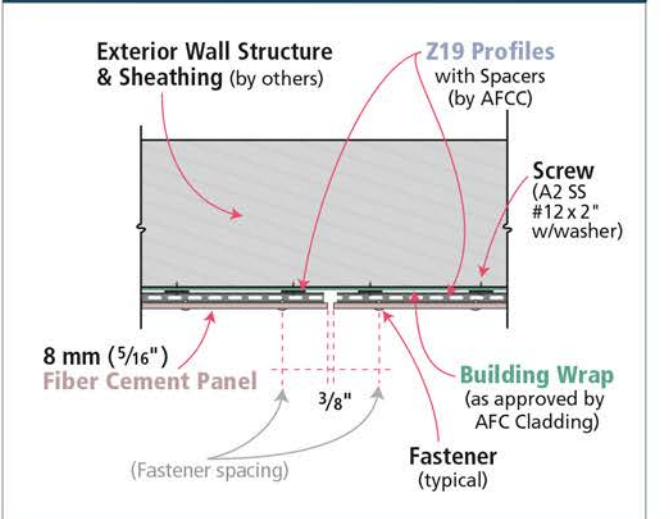

Typical Panel Base

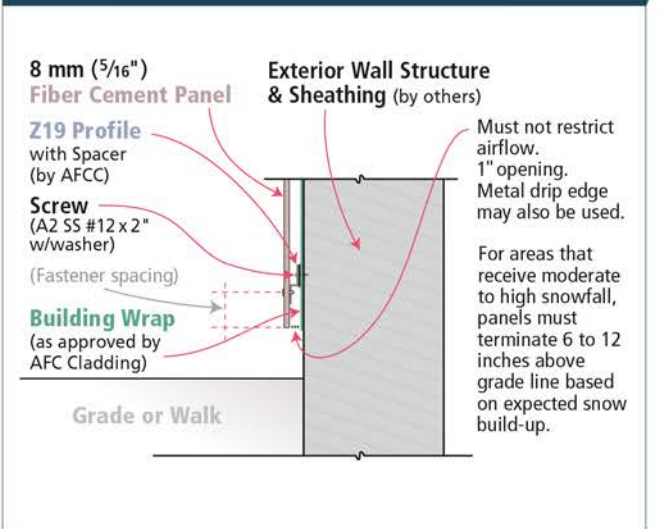

Details

(continued)

See AFC Standard Details for detailing requirements in architectural drawing format.

VENTILATED RAINSCREEN APPLICATION

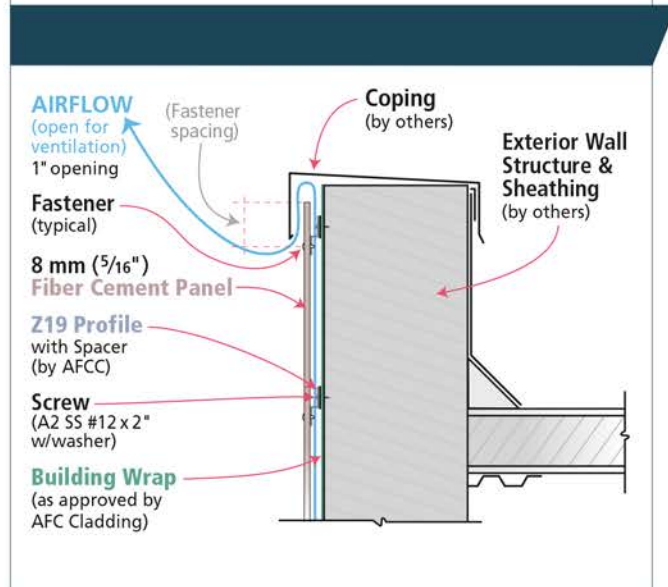
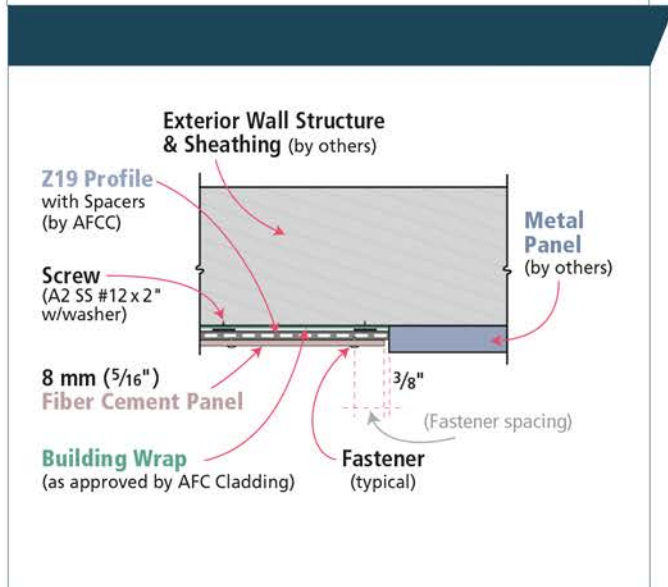
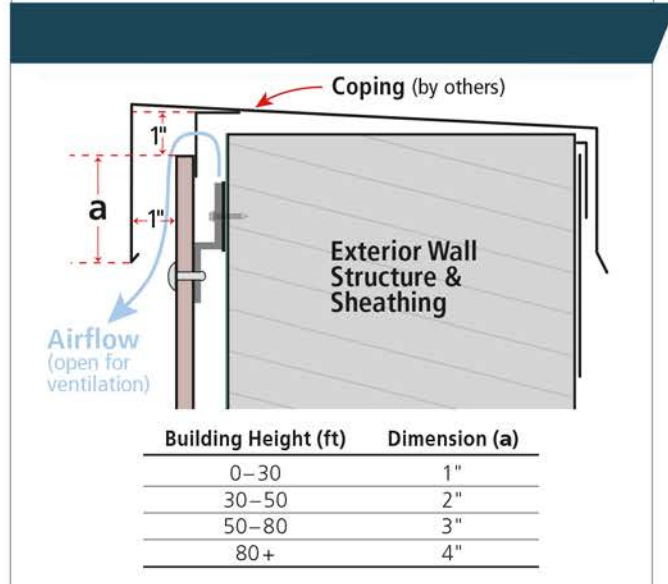
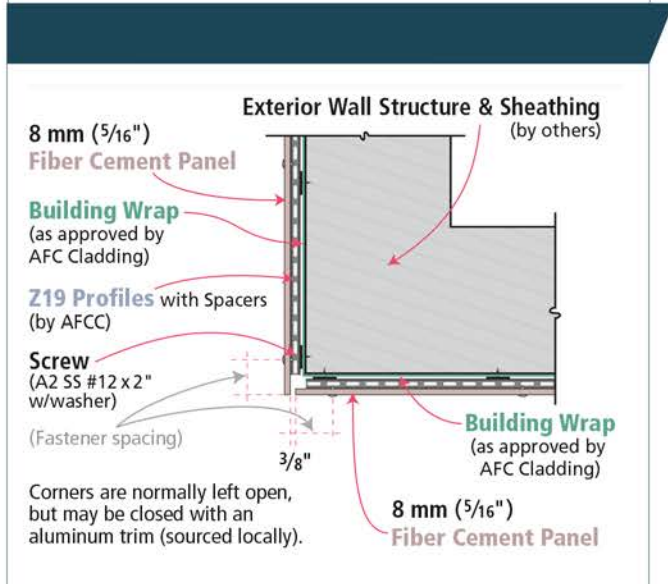
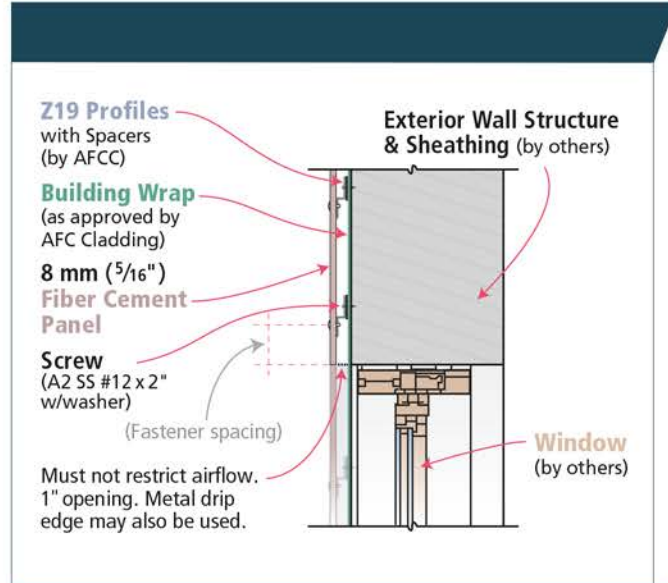
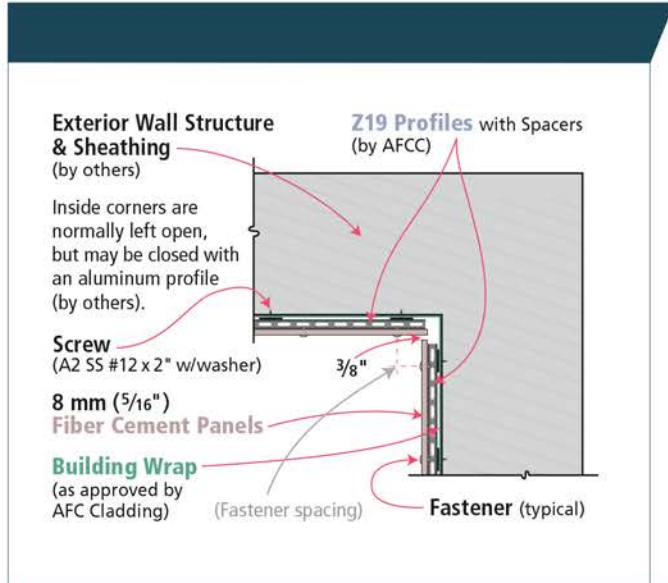

Product Sustainability Statement

AFC is committed to providing the highest quality high-density compressed fiber cement panels to the U.S. and Canadian building markets. In order to do this, we feel it necessary to provide not only high-quality products, but sustainable products that can contribute to green (LEED) building projects, which in turn benefit the environment we all live in. AFC products currently have a potential contribution to various LEED credits including but not limited to:

Direct Contribution

Materials and Resources:

- Environmental Product Declarations
- Material Ingredients
- Building Life-cycle Impact Reduction

Indirect Contribution

Indoor Environmental Quality:

- Thermal Comfort

Energy and Atmosphere:

- Optimize Energy Performance

One of the most important sustainable attributes is the durability of AFC panels. With their long lifespan, virtually requiring no refurbishment, AFC panels can contribute to less replacement of materials and to drastically lower maintenance costs over the useful life of the building.

The Ventilated and Insulated Rainscreen Cladding (VIRSC) system, which is used to affix AFC panels to the exterior of a structure, offers many benefits and green attributes to the performance of the building envelope. Durability and resistance to moisture and mold build-up are noteworthy benefits. Equally important is its ability to accommodate external insulation.

In addition, AFC is dedicated to further research and analysis of our products to achieve additional LEED credits, and help further the cause of building sustainable and efficient buildings.

Warranty information available upon request.

6901 South Pierce Street
Suite 180, Littleton, CO 80128 U.S.A.
Phone: 303.972.5107, 800.688.8677

americanfibercement.com

For the nearest authorized fabricator, call 303.972.5107.

Distributed by:



Limited Warranty

See the warranty for specific product being installed. Product warranties range from 10 to 20 years.

Product warranties may be requested by reaching out to house@afcccladding.com.

